

## 200MHz Amplifiers

The EL5150, EL5151, EL5250, EL5251, and EL5451 are 200MHz bandwidth -3dB voltage mode feedback amplifiers with DC accuracy of 0.01%, 1mV offsets and 10kV/V open loop gains. These amplifiers are ideally suited for applications ranging from precision measurement instrumentation to high speed video and monitor applications. Capable of operating with as little as 1.4mA of current from a single supply ranging from 5V to 12V, dual supplies ranging from  $\pm 2.5V$  to  $\pm 5.0V$ , these amplifiers are also well suited for handheld, portable and battery-powered equipment.

Single amplifiers are offered in SOT-23 packages and duals in a 10 Ld MSOP package for applications where board space is critical. Quad amplifiers are available in a 14 Ld SOIC package. Additionally, singles and duals are available in the industry-standard 8 Ld SOIC package. All parts operate over the industrial temperature range of  $-40^{\circ}C$  to  $+85^{\circ}C$ .

## Features

- 200MHz -3dB bandwidth
- 67V/ $\mu s$  slew rate
- Very high open loop gains 50kV/V
- Low supply current = 1.4mA
- Single supplies from 5V to 12V
- Dual supplies from  $\pm 2.5V$  to  $\pm 5V$
- Fast disable on the EL5150 and EL5250
- Low cost
- Pb-free available (RoHS compliant)

## Applications

- Imaging
- Instrumentation
- Video
- Communications devices

## Pinouts

**EL5150**  
(8 LD SOIC)  
TOP VIEW

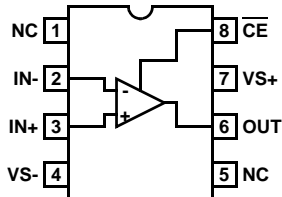

**EL5150**  
(6 LD SOT-23)  
TOP VIEW

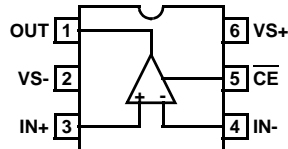

**EL5151**  
(5 LD SOT-23)  
TOP VIEW

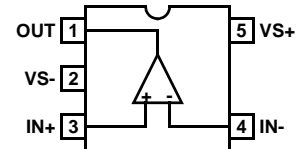

**EL5250**  
(10 LD MSOP)  
TOP VIEW

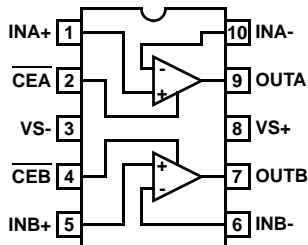

**EL5251**  
(8 LD MSOP)  
TOP VIEW

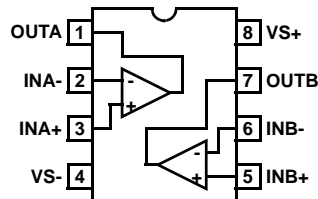

**EL5451**  
(14 LD SOIC)  
TOP VIEW

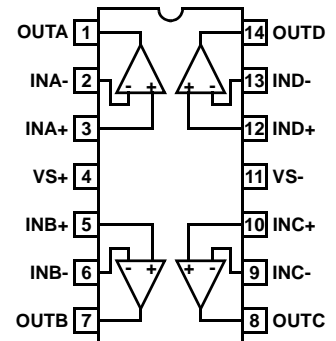

**EL5150, EL5151, EL5250, EL5251, EL5451**

**Ordering Information**

| PART NUMBER           | PART MARKING | PACKAGE                               | PKG. DWG. # |
|-----------------------|--------------|---------------------------------------|-------------|
| EL5150IS              | 5150IS       | 8 Ld SOIC                             | MDP0027     |
| EL5150IS-T7*          | 5150IS       | 8 Ld SOIC (Tape and Reel)             | MDP0027     |
| EL5150IS-T13*         | 5150IS       | 8 Ld SOIC (Tape and Reel)             | MDP0027     |
| EL5150ISZ (Note)      | 5150ISZ      | 8 Ld SOIC (Pb-free)                   | MDP0027     |
| EL5150ISZ-T7* (Note)  | 5150ISZ      | 8 Ld SOIC (Tape and Reel) (Pb-free)   | MDP0027     |
| EL5150ISZ-T13* (Note) | 5150ISZ      | 8 Ld SOIC (Tape and Reel) (Pb-free)   | MDP0027     |
| EL5150IW-T7*          | BEAA         | 6 Ld SOT-23 (Tape and Reel)           | MDP0038     |
| EL5150IW-T7A*         | BEAA         | 6 Ld SOT-23 (Tape and Reel)           | MDP0038     |
| EL5150IWZ-T7* (Note)  | BAAJ         | 6 Ld SOT-23 (Tape and Reel) (Pb-free) | MDP0038     |
| EL5150IWZ-T7A* (Note) | BAAJ         | 6 Ld SOT-23 (Tape and Reel) (Pb-free) | MDP0038     |
| EL5151IW-T7*          | BFAA         | 5 Ld SOT-23 (Tape and Reel)           | MDP0038     |
| EL5151IW-T7A*         | BFAA         | 5 Ld SOT-23 (Tape and Reel)           | MDP0038     |
| EL5151IWZ-T7* (Note)  | BAAK         | 5 Ld SOT-23 (Tape and Reel) (Pb-free) | MDP0038     |
| EL5151IWZ-T7A* (Note) | BAAK         | 5 Ld SOT-23 (Tape and Reel) (Pb-free) | MDP0038     |
| EL5250IY              | BAEAA        | 10 Ld MSOP                            | MDP0043     |
| EL5250IY-T7*          | BAEAA        | 10 Ld MSOP (Tape and Reel)            | MDP0043     |
| EL5250IY-T13*         | BAEAA        | 10 Ld MSOP (Tape and Reel)            | MDP0043     |
| EL5251IS              | 5251IS       | 8 Ld SOIC                             | MDP0027     |
| EL5251IS-T7*          | 5251IS       | 8 Ld SOIC (Tape and Reel)             | MDP0027     |
| EL5251IS-T13*         | 5251IS       | 8 Ld SOIC (Tape and Reel)             | MDP0027     |
| EL5251ISZ (Note)      | 5251ISZ      | 8 Ld SOIC (Pb-free)                   | MDP0027     |
| EL5251ISZ-T13* (Note) | 5251ISZ      | 8 Ld SOIC (Tape and Reel) (Pb-free)   | MDP0027     |
| EL5251ISZ-T7* (Note)  | 5251ISZ      | 8 Ld SOIC (Tape and Reel) (Pb-free)   | MDP0027     |
| EL5251IY              | BAFAA        | 8 Ld MSOP                             | MDP0043     |
| EL5251IY-T7*          | BAFAA        | 8 Ld MSOP (Tape and Reel)             | MDP0043     |
| EL5251IY-T13*         | BAFAA        | 8 Ld MSOP (Tape and Reel)             | MDP0043     |
| EL5251IYZ (Note)      | BBBHA        | 8 Ld MSOP (Pb-free)                   | MDP0043     |
| EL5251IYZ-T13* (Note) | BBBHA        | 8 Ld MSOP (Tape and Reel) (Pb-free)   | MDP0043     |
| EL5251IYZ-T7* (Note)  | BBBHA        | 8 Ld MSOP (Tape and Reel) (Pb-free)   | MDP0043     |
| EL5451IS              | 5451IS       | 14 Ld SOIC                            | MDP0027     |
| EL5451IS-T7*          | 5451IS       | 14 Ld SOIC (Tape and Reel)            | MDP0027     |
| EL5451IS-T13*         | 5451IS       | 14 Ld SOIC (Tape and Reel)            | MDP0027     |
| EL5451ISZ (Note)      | 5451ISZ      | 14 Ld SOIC (Pb-free)                  | MDP0027     |
| EL5451ISZ-T7* (Note)  | 5451ISZ      | 14 Ld SOIC (Tape and Reel) (Pb-free)  | MDP0027     |
| EL5451ISZ-T13* (Note) | 5451ISZ      | 14 Ld SOIC (Tape and Reel) (Pb-free)  | MDP0027     |

\*Please refer to TB347 for details on reel specifications.

NOTE: These Intersil Pb-free plastic packaged products employ special Pb-free material sets; molding compounds/die attach materials and 100% matte tin plate PLUS ANNEAL - e3 termination finish, which is RoHS compliant and compatible with both SnPb and Pb-free soldering operations. Intersil Pb-free products are MSL classified at Pb-free peak reflow temperatures that meet or exceed the Pb-free requirements of IPC/JEDEC J STD-020.

# EL5150, EL5151, EL5250, EL5251, EL5451

## Absolute Maximum Ratings (T<sub>A</sub> = +25°C)

|   |                                     |
|---|-------------------------------------|
| Supply Voltage between V <sub>S</sub> and V <sub>S-</sub> .....       | 13.2V                               |
| Slewrates of Voltage between V <sub>S</sub> and V <sub>S-</sub> ..... | 1V/μs                               |
| Maximum Continuous Output Current .....                               | 40mA                                |
| Pin Voltages .....  | GND - 0.5V to V <sub>S</sub> + 0.5V |
| Current into I <sub>N+</sub> , I <sub>N-</sub> , CE .....             | 5mA                                 |

## Thermal Information

|                                     |   |
|-------------------------------------|---|
| Junction Temperature .....          | -40°C to +125°C   |
| Storage Temperature .....           | -65°C to +150°C   |
| Ambient Operating Temperature ..... | -40°C to +85°C  |
| Power Dissipation .....             | See Curves  |
| Pb-Free Reflow Profile .....        | see link below  |
|                                     | <a href="http://www.intersil.com/pbfree/Pb-FreeReflow.asp">http://www.intersil.com/pbfree/Pb-FreeReflow.asp</a> |

**CAUTION:** Do not operate at or near the maximum ratings listed for extended periods of time. Exposure to such conditions may adversely impact product reliability and result in failures not covered by warranty.

**IMPORTANT NOTE:** All parameters having Min/Max specifications are guaranteed. Typical values are for information purposes only. Unless otherwise noted, all tests are at the specified temperature and are pulsed tests, therefore: T<sub>J</sub> = T<sub>C</sub> = T<sub>A</sub>

## Electrical Specifications V<sub>S+</sub> = +5V, V<sub>S-</sub> = -5V, R<sub>L</sub> = 150Ω, T<sub>A</sub> = +25°C, unless otherwise specified.

| PARAMETER                      | DESCRIPTION                                  | CONDITIONS  | MIN  | TYP  | MAX  | UNIT   |
|--------------------------------|--|---|------|------|------|--------|
| <b>AC PERFORMANCE</b>          |  |   |      |      |      |        |
| BW                             | -3dB Bandwidth                               | A <sub>V</sub> = +1, R <sub>L</sub> = 500Ω                        |      | 200  |      | MHz    |
|                                |  | A <sub>V</sub> = +2, R <sub>L</sub> = 150Ω                        |      | 40   |      | MHz    |
| GBWP                           | Gain Bandwidth Product                       | A <sub>V</sub> = 500  |      | 40   |      | MHz    |
| BW1                            | 0.1dB Bandwidth                              | A <sub>V</sub> = +1, R <sub>L</sub> = 500Ω                        |      | 10   |      | MHz    |
| SR                             | Slew Rate                                    | V <sub>O</sub> = ±2.5V, A <sub>V</sub> = +2                       | 50   | 67   |      | V/μs   |
|                                |  | V <sub>O</sub> = ±3.0V, A <sub>V</sub> = 1, R <sub>L</sub> = 500Ω |      | 100  |      | V/μs   |
| t <sub>S</sub>                 | 0.1% Settling Time                           | V <sub>OUT</sub> = -1V to +1V, A <sub>V</sub> = -2                |      | 80   |      | ns     |
| dG                             | Differential Gain Error (Note 1)             | A <sub>V</sub> = +2, R <sub>L</sub> = 150Ω                        |      | 0.04 |      | %      |
| dP                             | Differential Phase Error (Note 1)            | A <sub>V</sub> = +2, R <sub>L</sub> = 150Ω                        |      | 0.9  |      | °      |
| V <sub>N</sub>                 | Input Referred Voltage Noise                 |   |      | 12   |      | nV/√Hz |
| I <sub>N</sub>                 | Input Referred Current Noise                 |   |      | 1.0  |      | pA/√Hz |
| <b>DC PERFORMANCE</b>          |  |   |      |      |      |        |
| V <sub>OS</sub>                | Offset Voltage                               |   | -1   | 0.5  | 1    | mV     |
| T <sub>C</sub> V <sub>OS</sub> | Input Offset Voltage Temperature Coefficient | Measured from T <sub>MIN</sub> to T <sub>MAX</sub>                |      | -2   |      | μV/°C  |
| A <sub>VOL</sub>               | Open Loop Gain                               |   | 15   | 56   |      | kV/V   |
| <b>INPUT CHARACTERISTICS</b>   |  |   |      |      |      |        |
| CMIR                           | Common Mode Input Range                      | Guaranteed by CMRR test   | -3.5 |      | +3.5 | V      |
| CMRR                           | Common Mode Rejection Ratio                  |   | 85   | 100  |      | dB     |
| I <sub>B</sub>                 | Input Bias Current                           |   | -100 | 20   | +100 | nA     |
| I <sub>OS</sub>                | Input Offset Current                         |   | -30  | 6    | 30   | nA     |
| R <sub>IN</sub>                | Input Resistance                             |   | 80   | 170  |      | MΩ     |
| C <sub>IN</sub>                | Input Capacitance                            |   |      | 1    |      | pF     |
| <b>OUTPUT CHARACTERISTICS</b>  |  |   |      |      |      |        |
| V <sub>OUT</sub>               | Output Voltage Swing Low                     | R <sub>L</sub> = 150Ω to GND                                      | ±2.5 | ±2.8 |      | V      |
|                                |  | R <sub>L</sub> = 500Ω to GND                                      | ±3.1 | ±3.4 |      | V      |
| I <sub>OUT</sub>               | Output Current                               | R <sub>L</sub> = 10Ω to GND                                       | ±40  | ±70  |      | mA     |

# EL5150, EL5151, EL5250, EL5251, EL5451

## Electrical Specifications $V_{S+} = +5V, V_{S-} = -5V, R_L = 150\Omega, T_A = +25^\circ C$ , unless otherwise specified. (Continued)

| PARAMETER                              | DESCRIPTION                                      | CONDITIONS                                  | MIN          | TYP  | MAX          | UNIT    |
|--|--|---|--------------|------|--------------|---------|
| <b>ENABLE (SELECTED PACKAGES ONLY)</b> |  |   |              |      |              |         |
| $t_{EN}$                               | Enable Time                                      | EL5150                                      |              | 210  |              | ns      |
| $t_{DIS}$                              | Disable Time                                     | EL5150                                      |              | 620  |              | ns      |
| $I_{IHCE}$                             | $\overline{CE}$ Pin Input High Current           | $\overline{CE} = V_{S+}$                    | 1            | 5    | 25           | $\mu A$ |
| $I_{ILCE}$                             | $\overline{CE}$ Pin Input Low Current            | $\overline{CE} = V_{S+} - 5V$               | -1           | 0    | +1           | $\mu A$ |
| $V_{IHCE}$                             | $\overline{CE}$ Input High Voltage for Powerdown | Disable                                     | $V_{S+} - 1$ |      |              | V       |
| $V_{ILCE}$                             | $\overline{CE}$ Input Low Voltage for Powerdown  | Enable                                      |              |      | $V_{S+} - 3$ | V       |
| <b>SUPPLY</b>                          |  |   |              |      |              |         |
| $I_{SON}$                              | Supply Current - Enabled (per amplifier)         | No load, $V_{IN} = 0V, \overline{CE} = +5V$ | 1.12         | 1.35 | 1.6          | mA      |
| $I_{SOFF+}$                            | Supply Current - Disabled (per amplifier)        |   | -10          | -1   | +5           | $\mu A$ |
| $I_{SOFF-}$                            | Supply Current - Disabled (per amplifier)        | No load, $V_{IN} = 0V$                      | -25          | -14  | 0            | $\mu A$ |
| PSRR                                   | Power Supply Rejection Ratio                     | DC, $V_S = \pm 3.0V$ to $\pm 6.0V$          | 80           | 110  |              | dB      |

**NOTE:**

- Standard NTSC test, AC signal amplitude = 286mV<sub>p-p</sub>, f = 3.58MHz,  $V_{OUT}$  is swept from 0.8V to 3.4V,  $R_L$  is DC-coupled.

## Typical Performance Curves

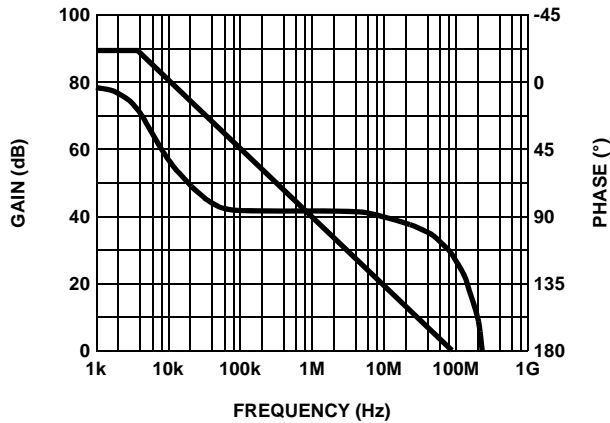

**FIGURE 1. EL5150 FREQUENCY vs OPEN LOOP GAIN/PHASE**

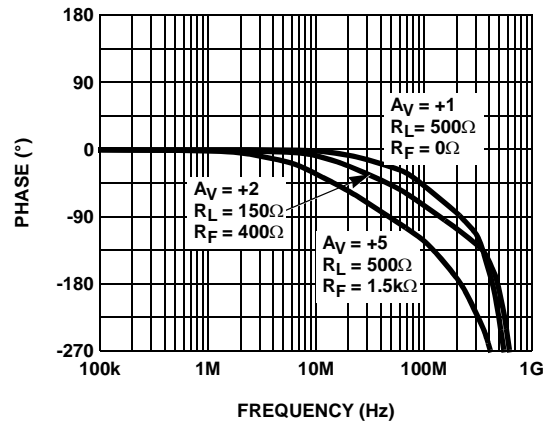

**FIGURE 2. PHASE vs FREQUENCY FOR VARIOUS GAINS**

Typical Performance Curves (Continued)

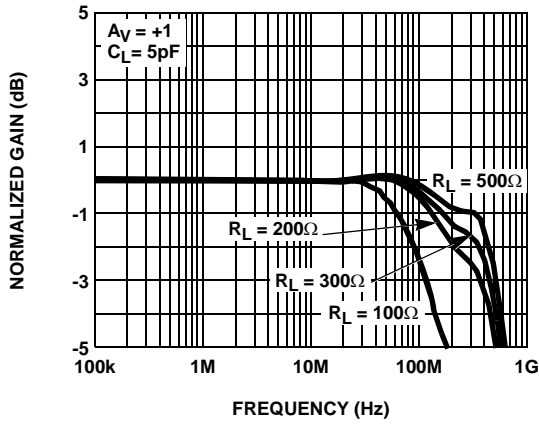

FIGURE 3. EL5150 GAIN vs FREQUENCY FOR VARIOUS  $R_L$

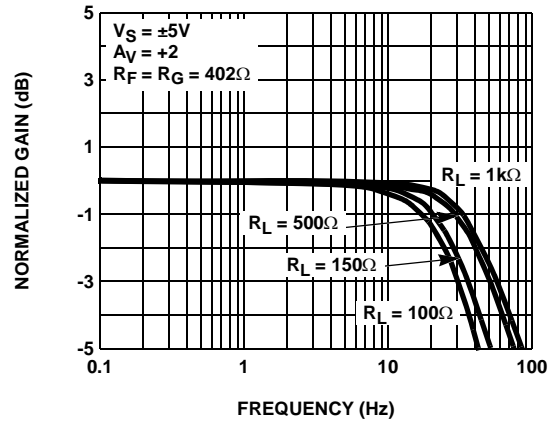

FIGURE 4. EL5150 GAIN vs FREQUENCY FOR VARIOUS  $R_L$

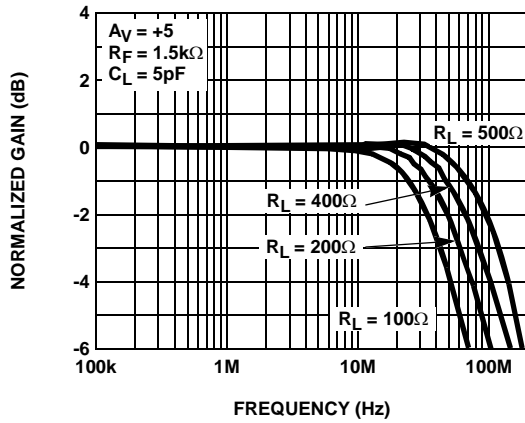

FIGURE 5. EL5150 GAIN vs FREQUENCY FOR VARIOUS  $R_L$

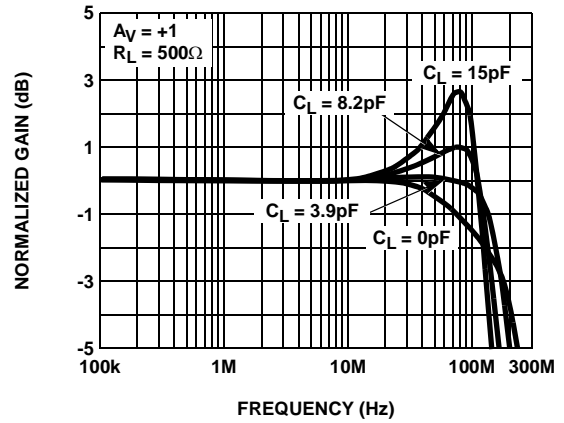

FIGURE 6. EL5150 GAIN vs FREQUENCY FOR VARIOUS  $C_L$

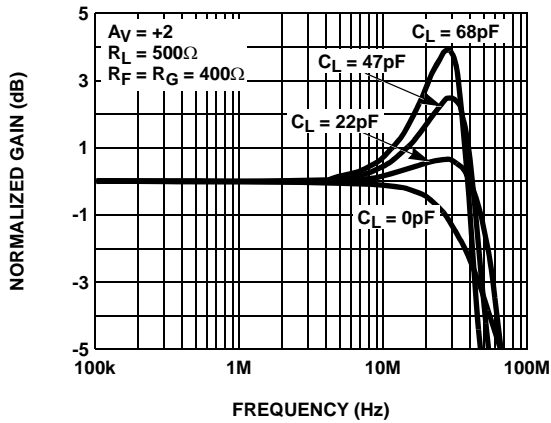

FIGURE 7. EL5150 GAIN vs FREQUENCY FOR VARIOUS  $C_L$

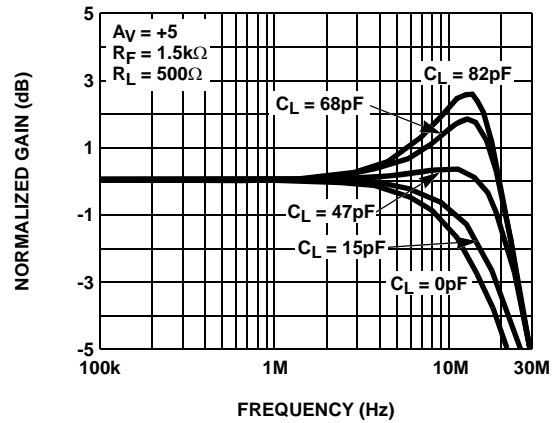

FIGURE 8. EL5150 GAIN vs FREQUENCY FOR VARIOUS  $C_L$

Typical Performance Curves (Continued)

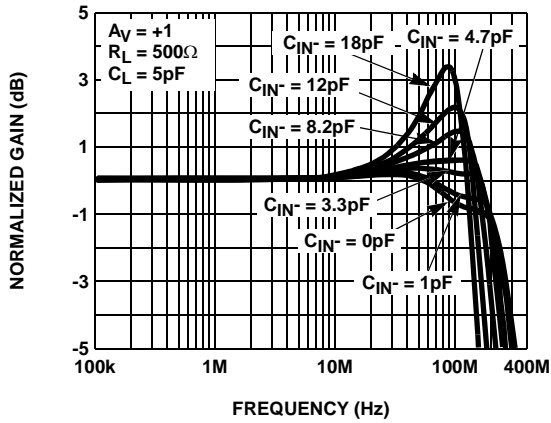

FIGURE 9. EL5150 GAIN vs FREQUENCY FOR VARIOUS  $C_{IN}$

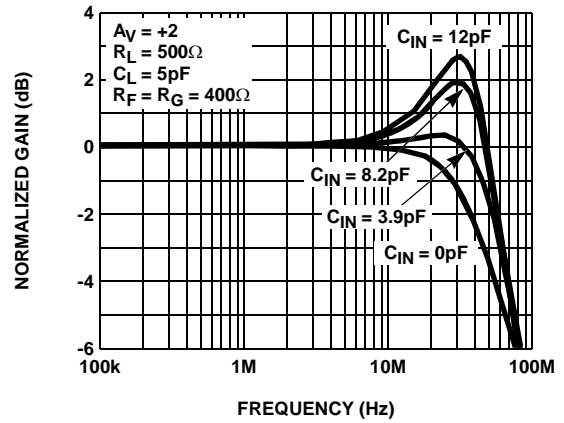

FIGURE 10. EL5150 GAIN vs FREQUENCY FOR VARIOUS  $C_{IN}$

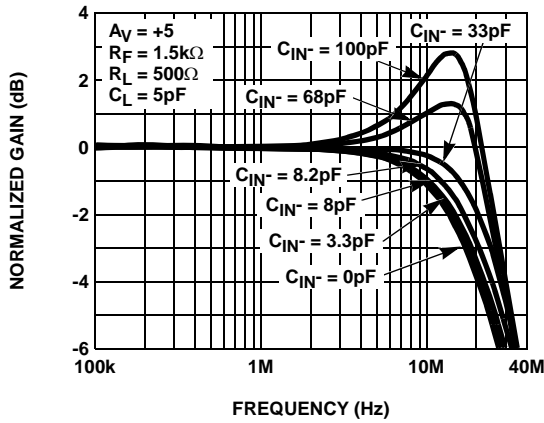

FIGURE 11. EL5150 GAIN vs FREQUENCY FOR VARIOUS  $C_{IN}$

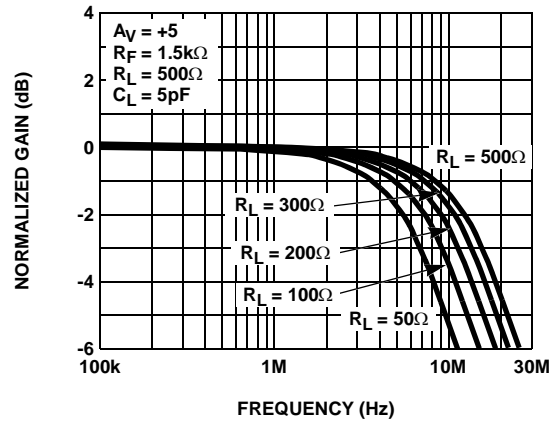

FIGURE 12. EL5250 GAIN vs FREQUENCY FOR VARIOUS  $R_L$

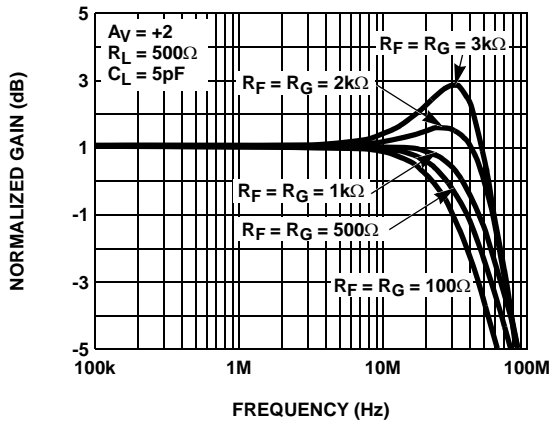

FIGURE 13. EL5150 GAIN vs FREQUENCY FOR VARIOUS  $R_F/R_G$

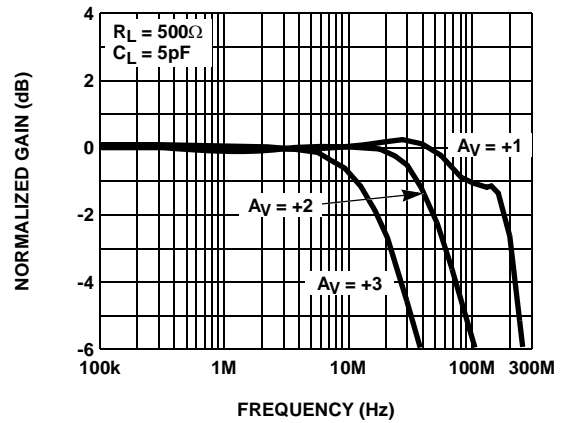

FIGURE 14. EL5250 GAIN vs FREQUENCY FOR VARIOUS GAINS

Typical Performance Curves (Continued)

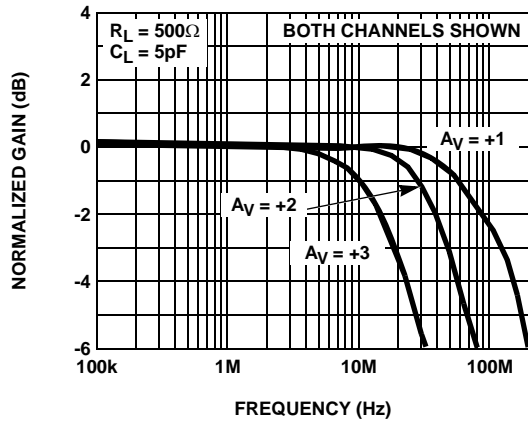

FIGURE 15. EL5250 GAIN vs FREQUENCY FOR VARIOUS GAINS

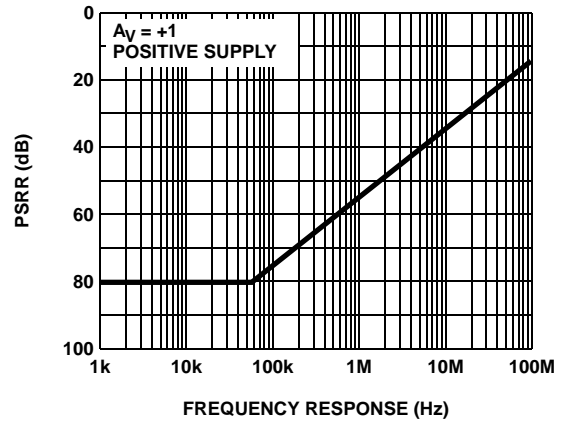

FIGURE 16. PSRR vs FREQUENCY

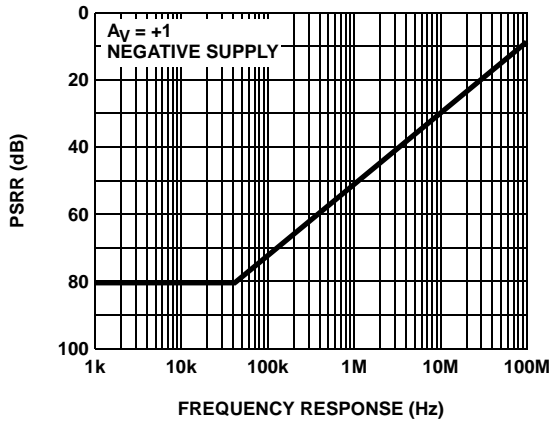

FIGURE 17. PSRR vs FREQUENCY

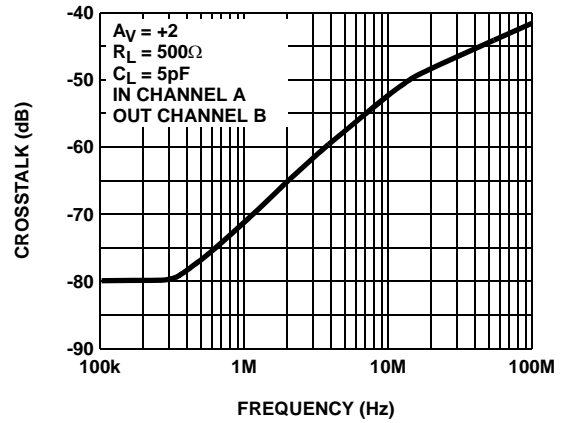

FIGURE 18. EL5250 CROSSTALK vs FREQUENCY

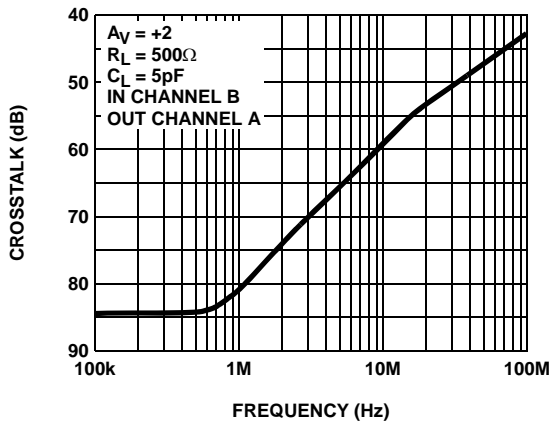

FIGURE 19. EL5250 CROSSTALK vs FREQUENCY

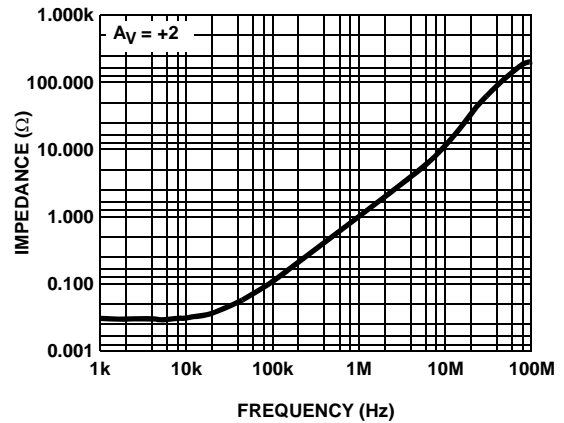

FIGURE 20. OUTPUT IMPEDANCE

Typical Performance Curves (Continued)

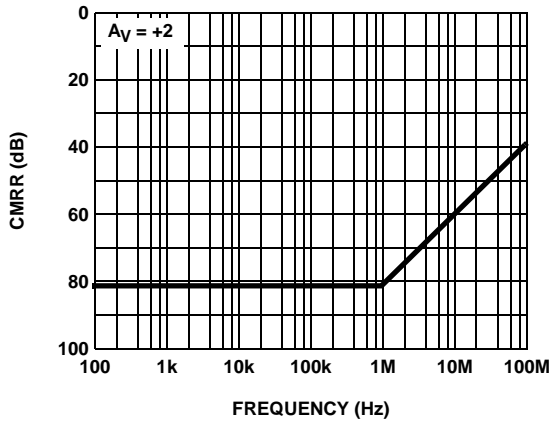

FIGURE 21. CMRR

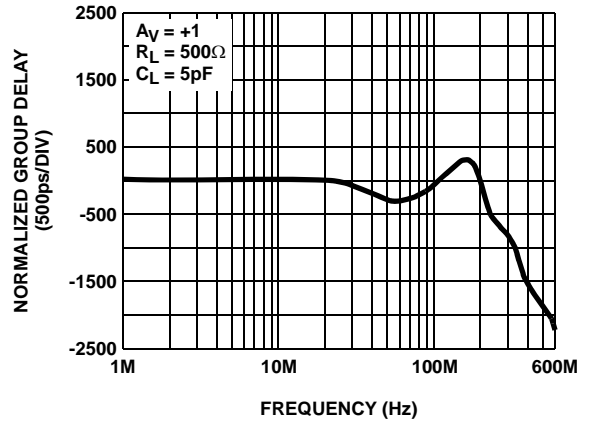

FIGURE 22. GROUP DELAY

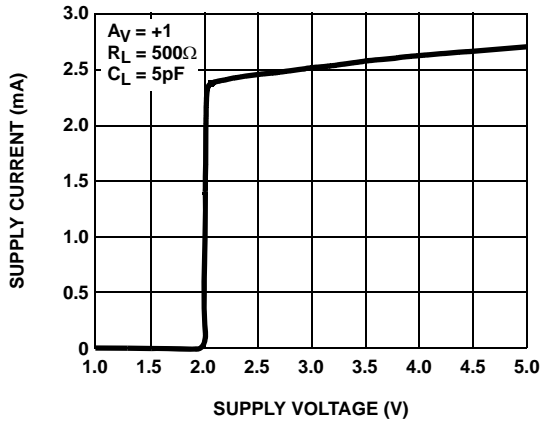

FIGURE 23. SUPPLY CURRENT vs SUPPLY VOLTAGE

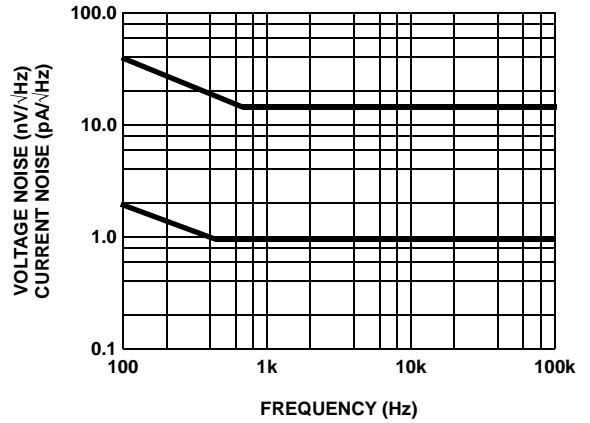

FIGURE 24. VOLTAGE + CURRENT NOISE vs FREQUENCY

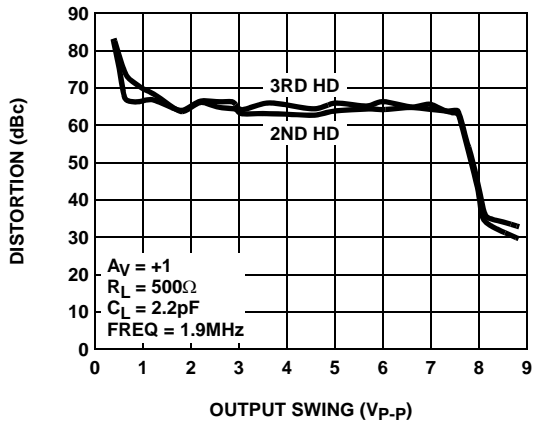

FIGURE 25. DISTORTION vs OUTPUT AMPLITUDE

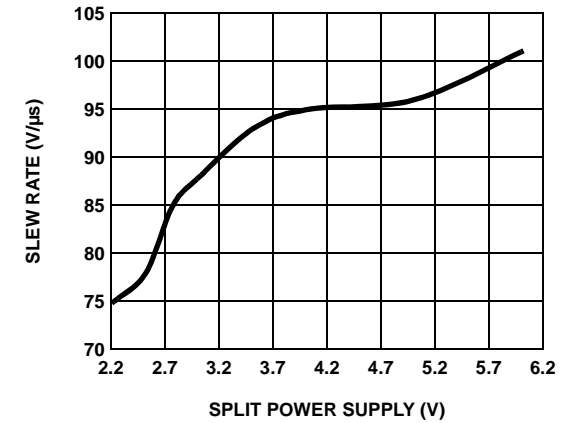

FIGURE 26. SLEW RATE vs POWER SUPPLY



Typical Performance Curves (Continued)

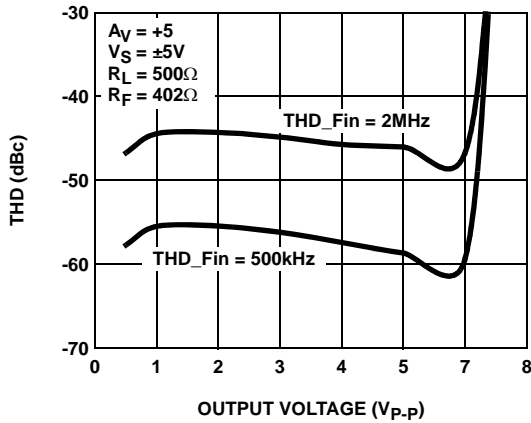

FIGURE 27. TOTAL HARMONIC DISTORTION vs OUTPUT VOLTAGE

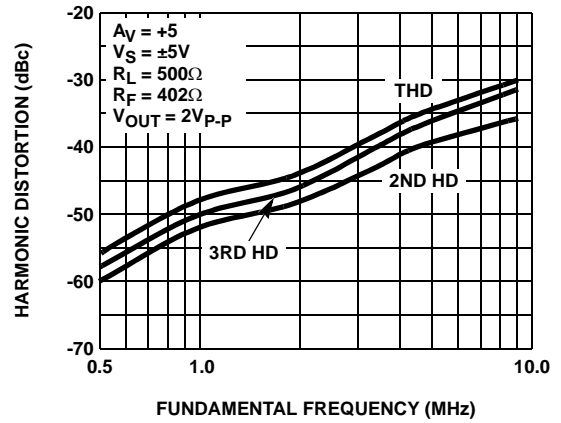

FIGURE 28. HARMONIC DISTORTION vs FREQUENCY

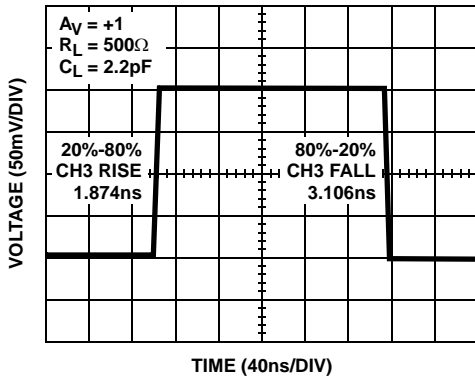

FIGURE 29. SMALL SIGNAL STEP RESPONSE

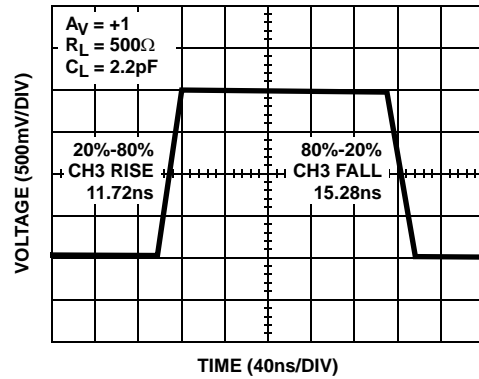

FIGURE 30. LARGE SIGNAL STEP RESPONSE

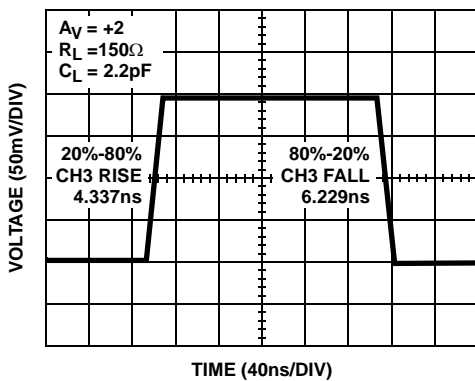

FIGURE 31. SMALL SIGNAL STEP RESPONSE

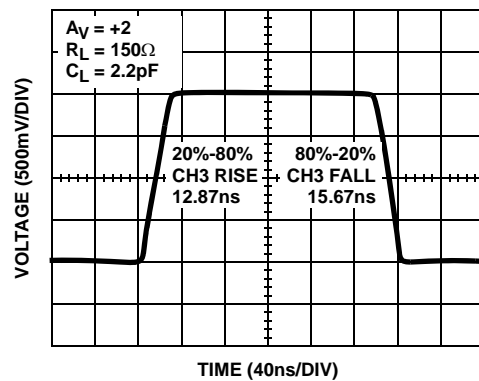

FIGURE 32. LARGE SIGNAL STEP RESPONSE

Typical Performance Curves (Continued)

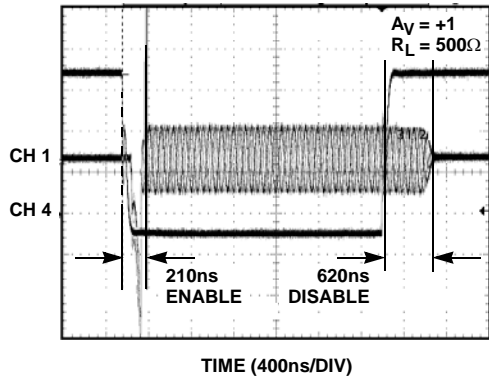

FIGURE 33. EL5150 ENABLE/DISABLE

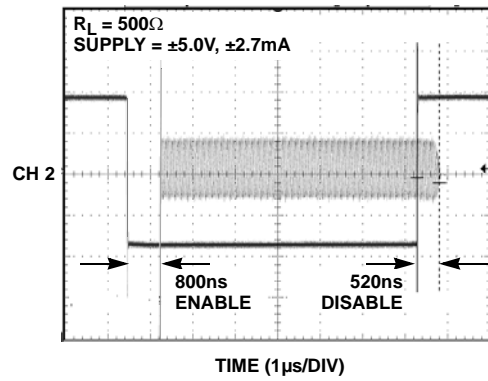

FIGURE 34. EL5250 ENABLE/DISABLE

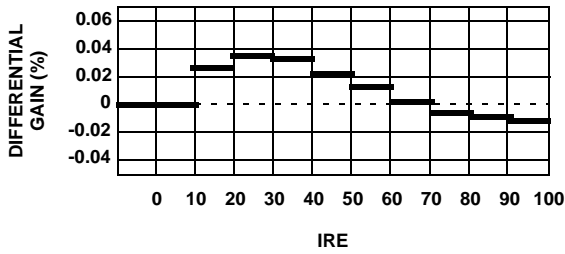

FIGURE 35. DIFFERENTIAL GAIN

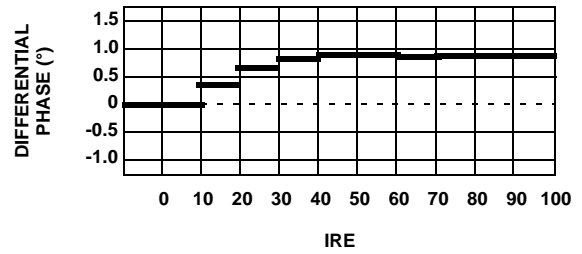

FIGURE 36. DIFFERENTIAL PHASE

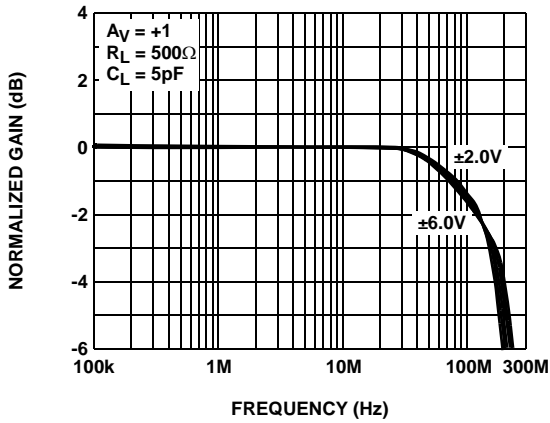

FIGURE 37. SMALL SIGNAL FREQUENCY vs SUPPLY

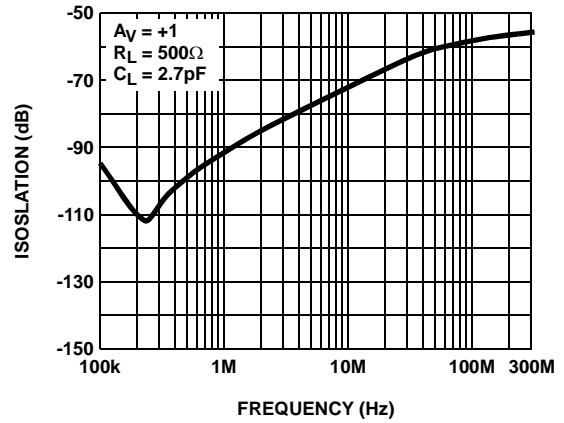

FIGURE 38. INPUT-TO-OUTPUT ISOLATION WITH PART DISABLED

Typical Performance Curves (Continued)

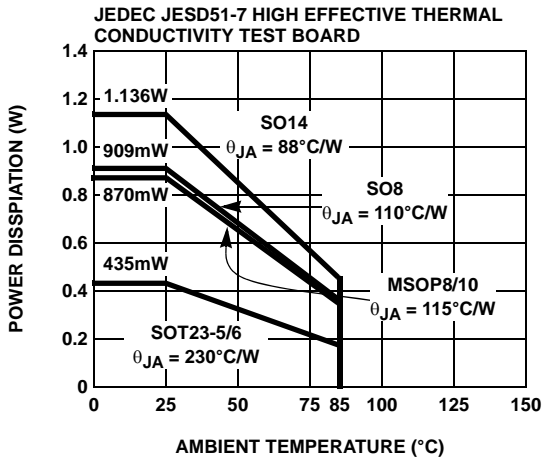

FIGURE 39. PACKAGE POWER DISSIPATION vs AMBIENT TEMPERATURE

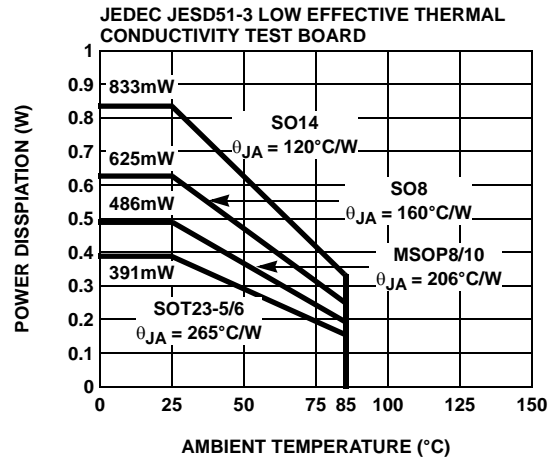

FIGURE 40. PACKAGE POWER DISSIPATION vs AMBIENT TEMPERATURE

Product Description

The EL5150, EL5151, EL5250, EL5251 and EL5451 are wide bandwidth, low power, low offset voltage feedback operational amplifiers capable of operating from a single or dual power supplies. This family of operational amplifiers are internally compensated for closed loop gain of +1 or greater. Connected in voltage follower mode, driving a 500Ω load members of this amplifier family demonstrate a -3dB bandwidth of about 200MHz. With the loading set to accommodate typical video application, 150Ω load and gain set to +2, bandwidth reduces to about 40MHz with a 67V/μs slew rate. Power down pins on the EL5151 and EL5251 reduce the already low power demands of this amplifier family to 12μA typical while the amplifier is disabled.

Input, Output and Supply Voltage Range

The EL5150 and family members have been designed to operate with supply voltage ranging from 5V to 12V. Supply voltages range from ±2.5V to ±5V for split supply operation. And of course split supply operation can easily be achieved using single supplies with by splitting off half of the single supply with a simple voltage divider as illustrated in the application circuit section.

Input Common Mode Range

These amplifiers have an input common mode voltage ranging from 3.5V above the negative supply (V<sub>S-</sub> pin) to 3.5V below the positive supply (V<sub>S+</sub> pin). If the input signal is driven beyond this range the output signal will exhibit distortion.

Maximum Output Swing & Load Resistance

The outputs of the EL5150 and family members exhibit maximum output swing ranges from -4V to 4V for V<sub>S</sub> = ±5V with a load resistance of 500Ω. Naturally, as the load resistance becomes lower, the output swing lowers

accordingly; for instance, if the load resistor is 150Ω, the output swing ranges from -3.5V to 3.5V. This response is a simple application of Ohms law indicating a lower value resistance results in greater current demands of the amplifier. Additionally, the load resistance affects the frequency response of this family as well as all operational amplifiers; as clearly indicated by the Gain vs Frequency For Various R<sub>L</sub> curves clearly indicate. In the case of the frequency response reduced bandwidth with decreasing load resistance is a function of load resistance in conjunction with the output zero response of the amplifier.

Choosing A Feedback Resistor

A feedback resistor is required to achieve unity gain; simply short the output pin to the inverting input pin. Gains greater than +1 require a feedback and gain resistor to set the desired gain. This gets interesting because the feedback resistor forms a pole with the parasitic capacitance at the inverting input; as the feedback resistance increases the position of the pole shifts in the frequency domain, the amplifier's phase margin is reduced and the amplifier becomes less stable. Peaking in the frequency domain and ringing in the time domain are symptomatic of this shift in pole location. So we want to keep the feedback resistor as small as possible. You may want to use a large feedback resistor for some reason; in this case to compensate the shift of the pole and maintain stability a small capacitor in the few Pico farad range in parallel with the feedback resistor is recommended.

For the gains greater than unity it has been determined a feedback resistance ranging from 500Ω to 750Ω provides optimal response.

**Gain Bandwidth Product**

The EL5150 and family members have a gain bandwidth product of 40MHz for a gain of +5. Bandwidth can be predicted by the following equation:

$$(Gain) \times (BW) = GainBandwidthProduct$$

**Video Performance**

For good video performance, an amplifier is required to maintain the same output impedance and same frequency response as DC levels are changed at the output; this characteristic is widely referred to as “diffgain-diffphase”. Many amplifiers have a difficult time with this especially while driving standard video loads of 150Ω, as the output current has a natural tendency to change with DC level. The dG and dP for these families is a respectable 0.04% and 0.9°, while driving 150Ω at a gain of 2. Driving high impedance loads would give a similar or better dG and dP performance as the current output demands placed on the amplifier lessen with increased load.

**Driving Capacitive Loads**

These devices can easily drive capacitive loads as demanding as 27pF in parallel with 500Ω while holding peaking to within 5dB of peaking at unity gain. Of course if less peaking is desired, a small series resistor (usually between 5Ω to 50Ω) can be placed in series with the output to eliminate most peaking; however, there will be a small sacrifice of gain which can be recovered by simply adjusting the value of the gain resistor.

**Driving Cables**

Both ends of all cables must always be properly terminated; double termination is absolutely necessary for reflection-free performance. Additionally, a back-termination series resistor at the amplifier’s output will isolate the amplifier from the cable and allow extensive capacitive drive. However, other applications may have high capacitive loads without a back-termination resistor. Again, a small series resistor at the output can help to reduce peaking.

**Disable/Power-Down**

Devices with disable can be disabled with their output placed in a high impedance state. The turn off time is about 330ns and the turn on time is about 130ns. When disabled, the amplifier’s supply current is reduced to 17μA typically; essentially eliminating power consumption. The amplifier’s power down is controlled by standard TTL or CMOS signal levels at the ENABLE pin. The applied logic signal is relative to V<sub>S-</sub> pin. Letting the ENABLE pin float or the application of a signal that is less than 0.8V above V<sub>S-</sub> enables the amplifier. The amplifier is disabled when the signal at ENABLE pin is above V<sub>S+</sub> - 1.5V.

**Output Drive Capability**

Members of the EL5150 family do not have internal short circuit protection circuitry. Typically, short circuit currents

ranging from 70mA and 95mA can be expected and naturally, if the output is shorted indefinitely the part can easily be damaged from overheating; or excessive current density may eventually compromise metal integrity. Maximum reliability is maintained if the output current is always held below ±40mA. This limit is set and limited by the design of the internal metal interconnect. Note that in transient applications, the part is extremely robust.

**Power Dissipation**

With the high output drive capability of these devices, it is possible to exceed the +125°C absolute maximum junction temperature under certain load current conditions. Therefore, it is important to calculate the maximum junction temperature for an application to determine if load conditions or package types need to be modified to assure operation of the amplifier in a safe operating area.

The maximum power dissipation allowed in a package is determined according to Equation 1:

$$PD_{MAX} = \frac{T_{JMAX} - T_{AMAX}}{\Theta_{JA}} \tag{EQ. 1}$$

Where:

T<sub>JMAX</sub> = Maximum junction temperature

T<sub>AMAX</sub> = Maximum ambient temperature

Θ<sub>JA</sub> = Thermal resistance of the package

The maximum power dissipation actually produced by an IC is the total quiescent supply current times the total power supply voltage, plus the power in the IC due to the load, or:

For sourcing:

$$PD_{MAX} = V_S \times I_{SMAX} + \sum_{i=1}^n (V_S - V_{OUTi}) \times \frac{V_{OUTi}}{R_{Li}} \tag{EQ. 2}$$

For sinking:

$$PD_{MAX} = V_S \times I_{SMAX} + \sum_{i=1}^n (V_{OUTi} - V_S) \times I_{LOADi} \tag{EQ. 3}$$

Where:

V<sub>S</sub> = Supply voltage

I<sub>SMAX</sub> = Maximum quiescent supply current

V<sub>OUT</sub> = Maximum output voltage of the application

R<sub>LOAD</sub> = Load resistance tied to ground

I<sub>LOAD</sub> = Load current

N = number of amplifiers (Max = 2)

By setting the two PD<sub>MAX</sub> equations equal to each other, we can solve the output current and R<sub>LOAD</sub> to avoid the device overheat.

**Power Supply Bypassing Printed Circuit Board Layout**

As with any high frequency device, a good printed circuit board layout is necessary for optimum performance. Lead lengths should be as short as possible. The power supply pin must be well bypassed to reduce the risk of oscillation. For normal single supply operation, where the  $V_{S-}$  pin is connected to the ground plane, a single 4.7µF tantalum capacitor in parallel with a 0.1µF ceramic capacitor from  $V_{S+}$  to GND will suffice. This same capacitor combination should be placed at each supply pin to ground if split supplies are to be used. In this case, the  $V_{S-}$  pin becomes the negative supply rail.

**Printed Circuit Board Layout**

For good AC performance, parasitic capacitance should be kept to a minimum. Use of wire wound resistors should be avoided because of their additional series inductance. Use of sockets should also be avoided if possible. Sockets add parasitic inductance and capacitance that can result in

compromised performance. Minimizing parasitic capacitance at the amplifier's inverting input pin is very important. The feedback resistor should be placed very close to the inverting input pin. Strip line design techniques are recommended for the signal traces.

**Application Circuits**

**Sallen Key Low Pass Filter**

A common and easy to implement filter taking advantage of the wide bandwidth, low offset and low power demands of the EL5150. A derivation of the transfer function is provided for convenience (see Figure 41).

**Sallen Key High Pass Filter**

Again, this useful filter benefits from the characteristics of the EL5150. The transfer function is very similar to the low pass so only the results are presented (see Figure 42).

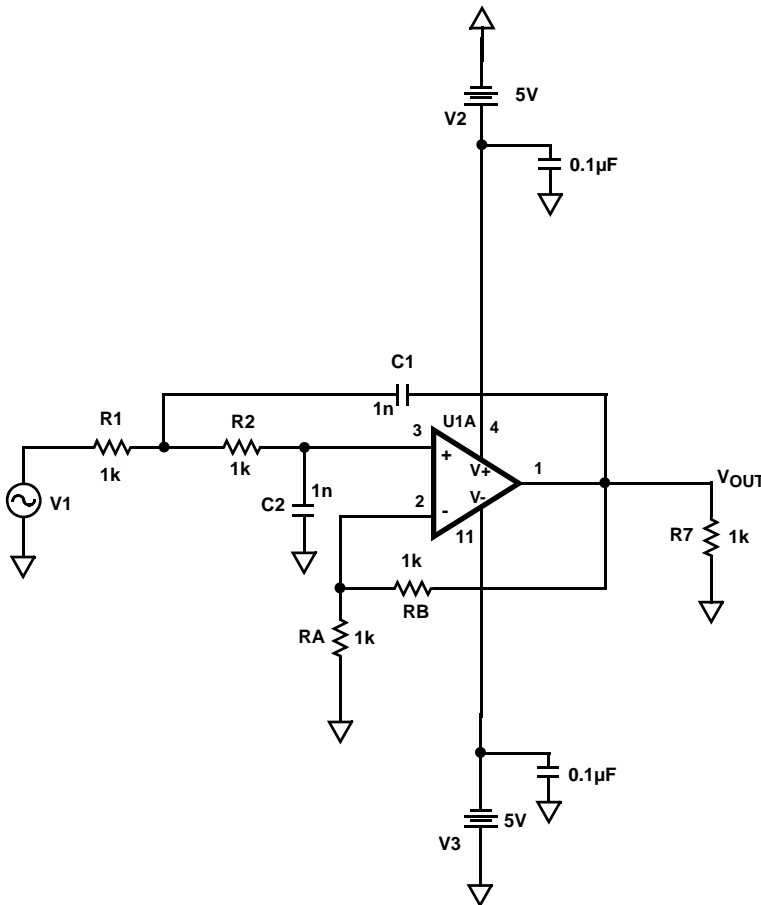

$$K = 1 + \frac{R_B}{R_A}$$

$$V_o = K \frac{1}{R_2 C_2 s + 1} V_1$$

$$\frac{V_1 - V_i}{R_1} + \frac{V_o}{R_2} + \frac{V_o - V_i}{\frac{1}{C_1 s}} = 0$$

$$H(s) = \frac{K}{R_1 C_1 R_2 C_2 s^2 + ((1-K)R_1 C_1 + R_1 C_2 + R_2 C_2) s + 1}$$

$$H(j\omega) = \frac{1}{1 - \omega^2 R_1 C_1 R_2 C_2 + j\omega((1-K)R_1 C_1 + R_1 C_2 + R_2 C_2)}$$

$$H_{olp} = K$$

$$\omega_o = \frac{1}{\sqrt{R_1 C_1 R_2 C_2}}$$

$$Q = \frac{1}{(1-K) \sqrt{\frac{R_1 C_1}{R_2 C_2}} + \sqrt{\frac{R_1 C_2}{R_2 C_1}} + \sqrt{\frac{R_2 C_2}{R_1 C_1}}}$$

$$H_{olp} = K$$

$$\omega_o = \frac{1}{RC}$$

$$Q = \frac{1}{3-K}$$

Equations simplify if we let all components be equal R = C

FIGURE 41. SALLEN KEY LOW PASS FILTER

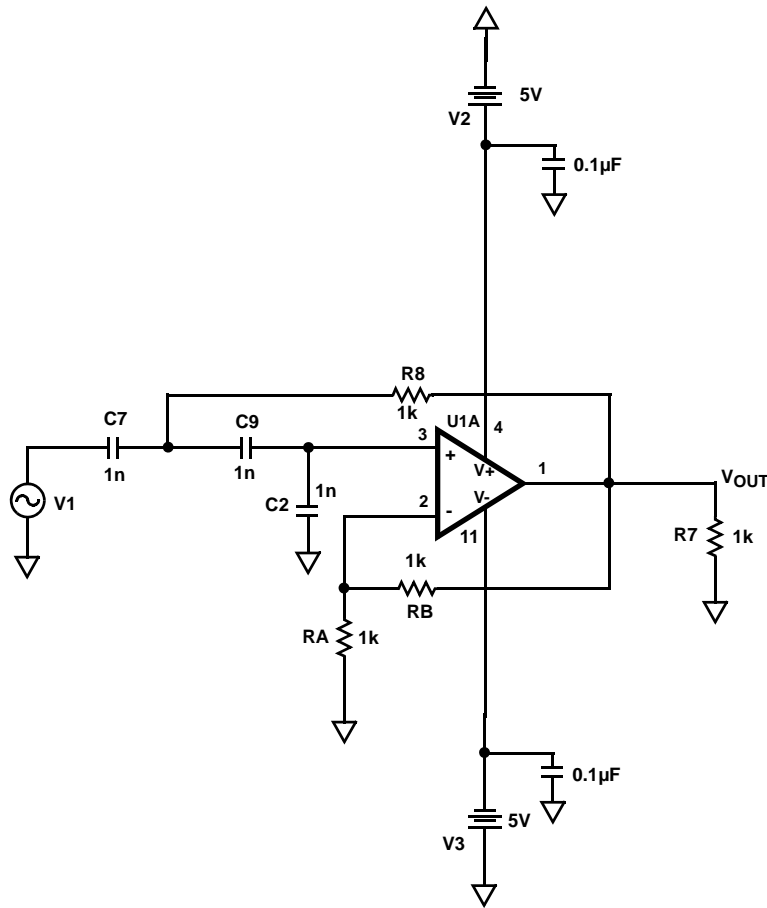

$$H_{olp} = K$$

$$\omega_o = \frac{1}{\sqrt{R_1 C_1 R_2 C_2}}$$

$$Q = \frac{1}{(1-K) \sqrt{\frac{R_1 C_1}{R_2 C_2}} + \sqrt{\frac{R_1 C_2}{R_2 C_1}} + \sqrt{\frac{R_2 C_2}{R_1 C_1}}}$$

$$H_{olp} = \frac{K}{4-K}$$

$$\omega_o = \frac{\sqrt{2}}{RC}$$

$$Q = \frac{\sqrt{2}}{4-K}$$

Equations simplify if we let all components be equal  $R = C$

FIGURE 42. SALLEN KEY HIGH PASS FILTER

### Differential Output Instrumentation Amplifier

The addition of a third amplifier to the conventional three amplifier Instrumentation Amplifier introduces the benefits of differential signal realization; specifically the advantage of using common mode rejection to remove coupled noise and ground –potential errors inherent in remote transmission. This configuration also provides enhanced bandwidth, wider output swing and faster slew rate than conventional three amplifier solutions with only the cost of an additional amplifier and few resistors.

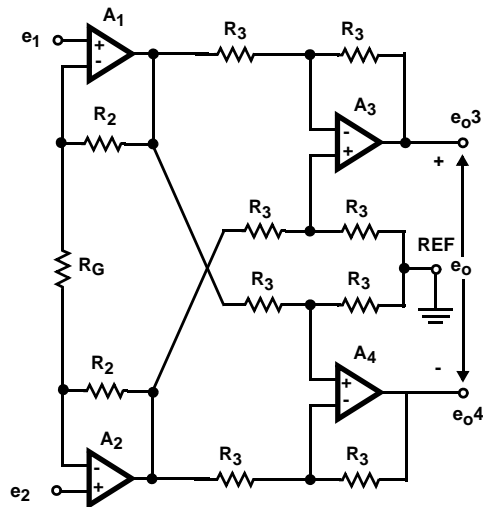

$$e_{o3} = -(1 + 2R_2/R_G)(e_1 - e_2) \quad e_{o4} = (1 + 2R_2/R_G)(e_1 - e_2)$$

$$e_o = -2(1 + 2R_2/R_G)(e_1 - e_2)$$

$$BW = \frac{2f_{C1,2}}{|A_{Di}|} \quad A_{Di} = -2(1 + 2R_2/R_G)$$

**Strain Gauge**

The strain gauge is an ideal application to take advantage of the moderate bandwidth and high accuracy of the EL5150. The operation of the circuit is very straight-forward. As the strain variable component resistor in the balanced bridge is subjected to increasing strain, its resistance changes

resulting in an imbalance in the bridge. A voltage variation from the referenced high accuracy source is generated and translated to the difference amplifier through the buffer stage. This voltage difference as a function of the strain is converted into an output voltage.

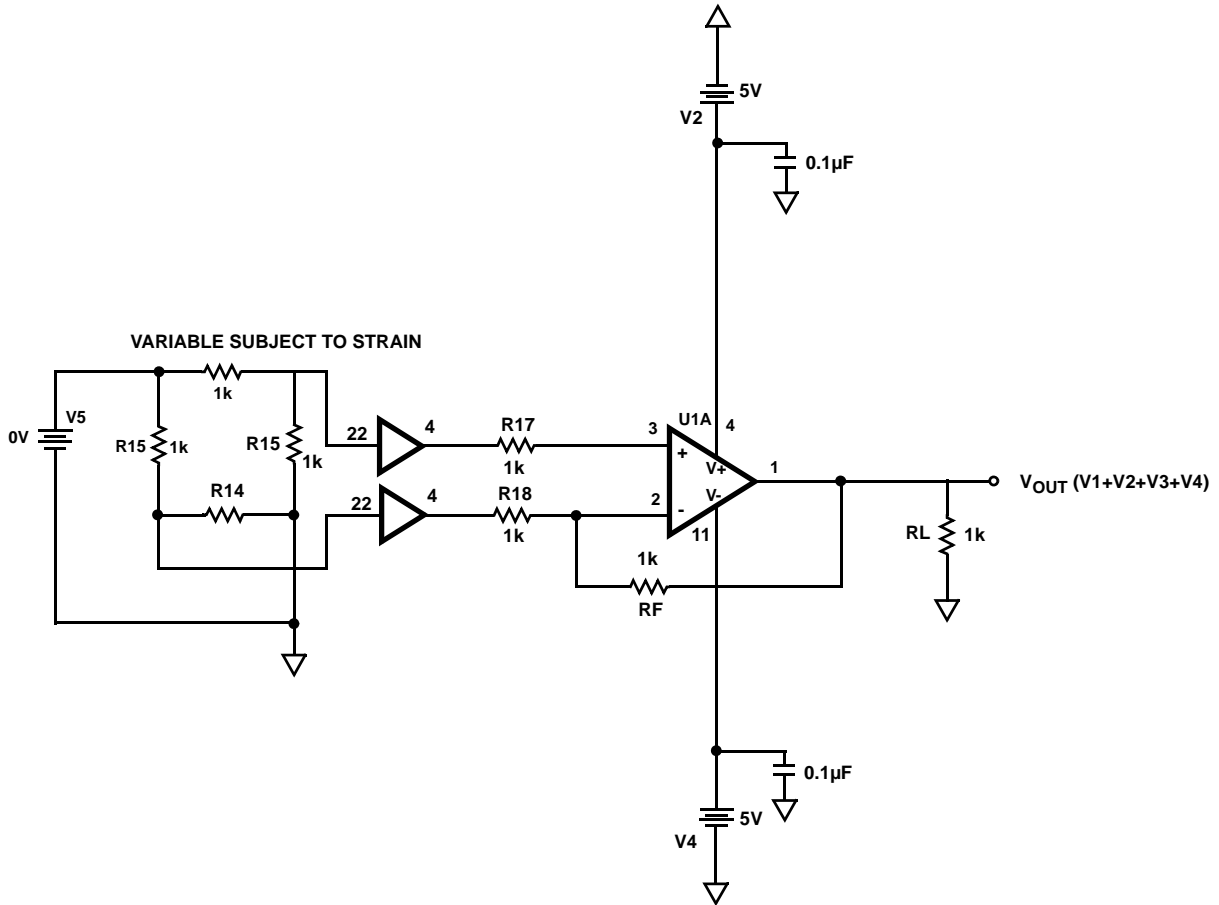

**Small Outline Package Family (SO)**

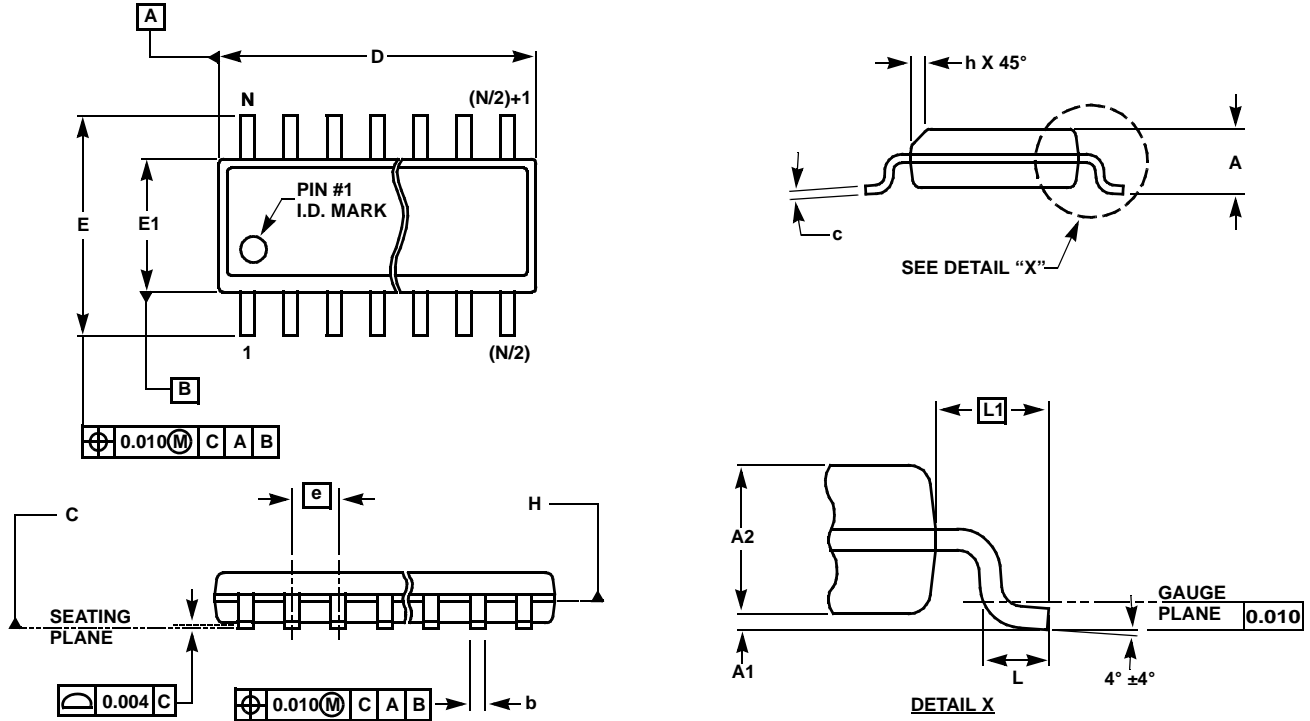

**MDP0027**

**SMALL OUTLINE PACKAGE FAMILY (SO)**

| SYMBOL | INCHES |       |               |                        |               |               |               | TOLERANCE | NOTES |
|--------|--------|-------|---------------|------------------------|---------------|---------------|---------------|-----------|-------|
|        | SO-8   | SO-14 | SO16 (0.150") | SO16 (0.300") (SOL-16) | SO20 (SOL-20) | SO24 (SOL-24) | SO28 (SOL-28) |           |       |
| A      | 0.068  | 0.068 | 0.068         | 0.104                  | 0.104         | 0.104         | 0.104         | MAX       | -     |
| A1     | 0.006  | 0.006 | 0.006         | 0.007                  | 0.007         | 0.007         | 0.007         | ±0.003    | -     |
| A2     | 0.057  | 0.057 | 0.057         | 0.092                  | 0.092         | 0.092         | 0.092         | ±0.002    | -     |
| b      | 0.017  | 0.017 | 0.017         | 0.017                  | 0.017         | 0.017         | 0.017         | ±0.003    | -     |
| c      | 0.009  | 0.009 | 0.009         | 0.011                  | 0.011         | 0.011         | 0.011         | ±0.001    | -     |
| D      | 0.193  | 0.341 | 0.390         | 0.406                  | 0.504         | 0.606         | 0.704         | ±0.004    | 1, 3  |
| E      | 0.236  | 0.236 | 0.236         | 0.406                  | 0.406         | 0.406         | 0.406         | ±0.008    | -     |
| E1     | 0.154  | 0.154 | 0.154         | 0.295                  | 0.295         | 0.295         | 0.295         | ±0.004    | 2, 3  |
| e      | 0.050  | 0.050 | 0.050         | 0.050                  | 0.050         | 0.050         | 0.050         | Basic     | -     |
| L      | 0.025  | 0.025 | 0.025         | 0.030                  | 0.030         | 0.030         | 0.030         | ±0.009    | -     |
| L1     | 0.041  | 0.041 | 0.041         | 0.056                  | 0.056         | 0.056         | 0.056         | Basic     | -     |
| h      | 0.013  | 0.013 | 0.013         | 0.020                  | 0.020         | 0.020         | 0.020         | Reference | -     |
| N      | 8      | 14    | 16            | 16                     | 20            | 24            | 28            | Reference | -     |

Rev. M 2/07

**NOTES:**

1. Plastic or metal protrusions of 0.006" maximum per side are not included.
2. Plastic interlead protrusions of 0.010" maximum per side are not included.
3. Dimensions "D" and "E1" are measured at Datum Plane "H".
4. Dimensioning and tolerancing per ASME Y14.5M-1994



SOT-23 Package Family

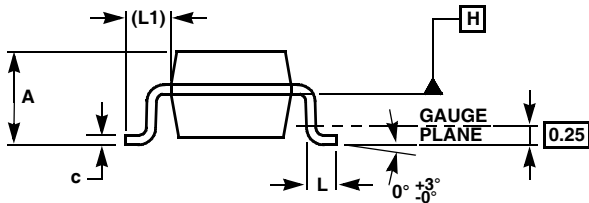
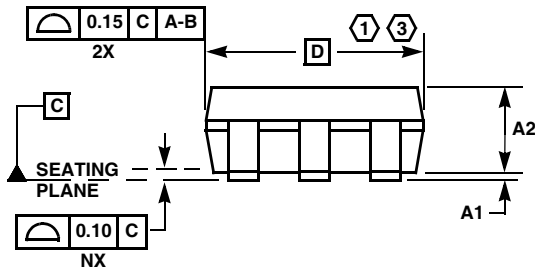
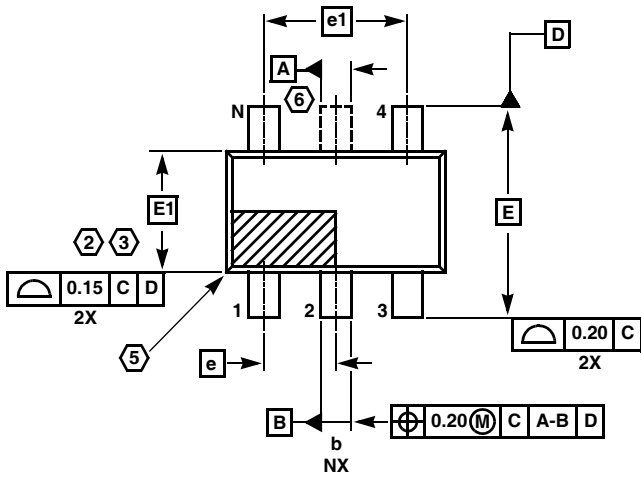

MDP0038

SOT-23 PACKAGE FAMILY

| SYMBOL | MILLIMETERS |         | TOLERANCE |
|--------|-------------|---------|-----------|
|        | SOT23-5     | SOT23-6 |           |
| A      | 1.45        | 1.45    | MAX       |
| A1     | 0.10        | 0.10    | ±0.05     |
| A2     | 1.14        | 1.14    | ±0.15     |
| b      | 0.40        | 0.40    | ±0.05     |
| c      | 0.14        | 0.14    | ±0.06     |
| D      | 2.90        | 2.90    | Basic     |
| E      | 2.80        | 2.80    | Basic     |
| E1     | 1.60        | 1.60    | Basic     |
| e      | 0.95        | 0.95    | Basic     |
| e1     | 1.90        | 1.90    | Basic     |
| L      | 0.45        | 0.45    | ±0.10     |
| L1     | 0.60        | 0.60    | Reference |
| N      | 5           | 6       | Reference |

Rev. F 2/07

NOTES:

1. Plastic or metal protrusions of 0.25mm maximum per side are not included.
2. Plastic interlead protrusions of 0.25mm maximum per side are not included.
3. This dimension is measured at Datum Plane "H".
4. Dimensioning and tolerancing per ASME Y14.5M-1994.
5. Index area - Pin #1 I.D. will be located within the indicated zone (SOT23-6 only).
6. SOT23-5 version has no center lead (shown as a dashed line).

Mini SO Package Family (MSOP)

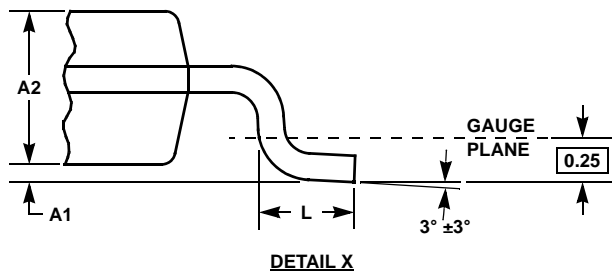
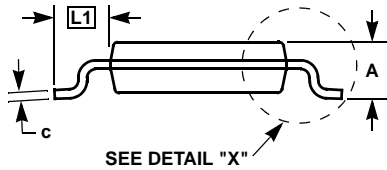
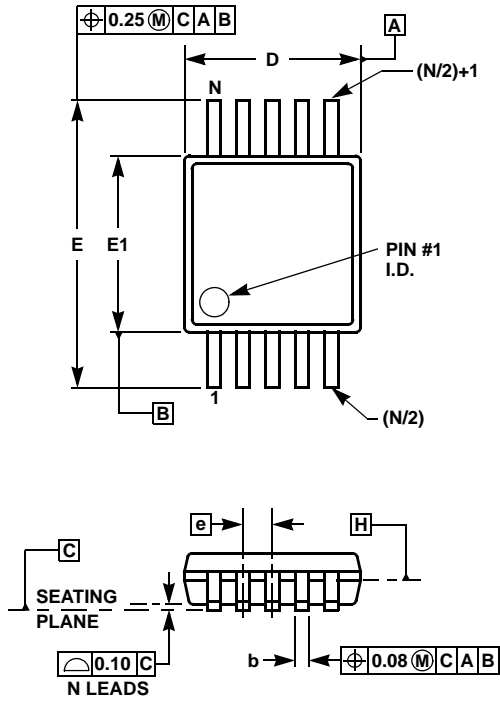

MDP0043  
MINI SO PACKAGE FAMILY

| SYMBOL | MILLIMETERS |        | TOLERANCE   | NOTES |
|--------|-------------|--------|-------------|-------|
|        | MSOP8       | MSOP10 |             |       |
| A      | 1.10        | 1.10   | Max.        | -     |
| A1     | 0.10        | 0.10   | ±0.05       | -     |
| A2     | 0.86        | 0.86   | ±0.09       | -     |
| b      | 0.33        | 0.23   | +0.07/-0.08 | -     |
| c      | 0.18        | 0.18   | ±0.05       | -     |
| D      | 3.00        | 3.00   | ±0.10       | 1, 3  |
| E      | 4.90        | 4.90   | ±0.15       | -     |
| E1     | 3.00        | 3.00   | ±0.10       | 2, 3  |
| e      | 0.65        | 0.50   | Basic       | -     |
| L      | 0.55        | 0.55   | ±0.15       | -     |
| L1     | 0.95        | 0.95   | Basic       | -     |
| N      | 8           | 10     | Reference   | -     |

Rev. D 2/07

NOTES:

1. Plastic or metal protrusions of 0.15mm maximum per side are not included.
2. Plastic interlead protrusions of 0.25mm maximum per side are not included.
3. Dimensions "D" and "E1" are measured at Datum Plane "H".
4. Dimensioning and tolerancing per ASME Y14.5M-1994.

All Intersil U.S. products are manufactured, assembled and tested utilizing ISO9000 quality systems. Intersil Corporation's quality certifications can be viewed at [www.intersil.com/design/quality](http://www.intersil.com/design/quality)

Intersil products are sold by description only. Intersil Corporation reserves the right to make changes in circuit design, software and/or specifications at any time without notice. Accordingly, the reader is cautioned to verify that data sheets are current before placing orders. Information furnished by Intersil is believed to be accurate and reliable. However, no responsibility is assumed by Intersil or its subsidiaries for its use; nor for any infringements of patents or other rights of third parties which may result from its use. No license is granted by implication or otherwise under any patent or patent rights of Intersil or its subsidiaries.

For information regarding Intersil Corporation and its products, see [www.intersil.com](http://www.intersil.com)